

# Infill Barrier Railing



AUSTRALIAN SECURITY INDUSTRY  
ASSOCIATION LIMITED

## Concept

The Centurion Infill system is a sleek and effective method for controlling the flow of traffic. It can be adapted to fill a variety of gaps and complements the aesthetics of both turnstiles and your building.

The Centurion Infill system combines toughed safety glass with stainless steel posts. The glass can be provided in different heights and layouts and have an option for engraved logos and signage.

## The CENTAMAN advantage...

- *Technically superior products*
- *Sydney based 24/7 support helpline*
- *Local offices for a faster response*
- *Flexible support packages*
- *Supply only to turnkey project delivery options*
- *14 Years experience in successfully delivering entrance control solutions*

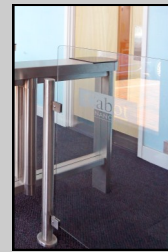

## Options

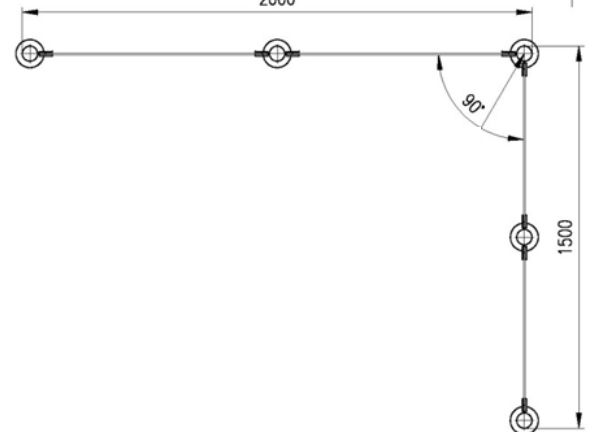
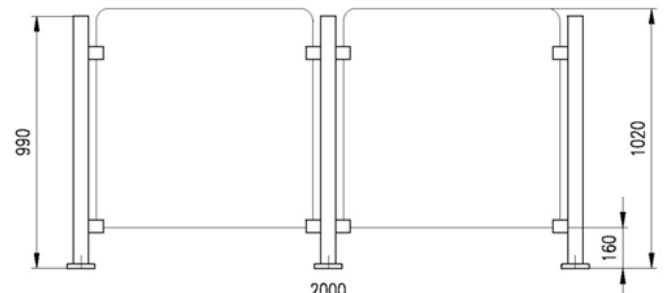
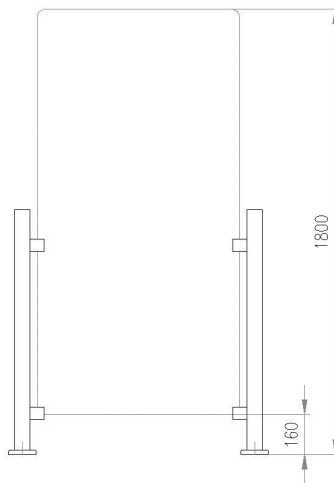
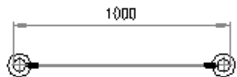
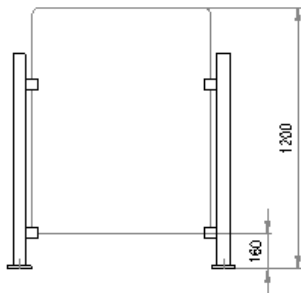
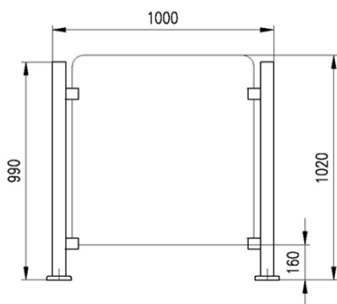

**CENTAMAN Entrance Control**  
Setting new standards in entrance control

W: [www.entrancecontrol.com.au](http://www.entrancecontrol.com.au)

E: [sales@entrancecontrol.com.au](mailto:sales@entrancecontrol.com.au)